

Network SIP Speaker Model: KNSIPSP-L4-30W



- > Clear, long-range speech
- > Simple installation with network cable
- > Supports SIP (VoIP)
- > Clear and simple

KNSIPSP-L4-30W Network Horn Speaker is a simple-to-install outdoor loudspeaker that provides clear, long-range speech for remote speaking in video surveillance applications.

In live monitoring situations, KNSIPSP-L4-30W enables an operator to remotely address people and deter unwanted activity. The loudspeaker can also play a pre-recorded audio file when it is manually or automatically triggered in response to an alarm event.

KNSIPSP-L4-30W makes announcements possible from any-where with network connectivity and easily integrates Voice over IP (VoIP) telephony systems that use SIP (Session Initiation Protocol).

The outdoor-ready KNSIPSP-L4-30W is easy to install. The loudspeaker has a built-in amplifier and supports over Ethernet. It connects directly to an IP network with one network cable for communication. It is powered supply by AC110~240V. KNSIPSP-L4-30W enables a high sound pressure exceeding 109~125 dB. Being a standalone unit, KNSIPSP-L4-30W can be placed anywhere, enabling a flexible, scalable and cost-effective approach to system design.





The speaker comes with pre-recorded audio files and allows users to upload their own audio.

Audio	
Audio streaming	One-way/ (Differential output)
Audio compression	G.711 PCM 8 kHz, G.726 ADPCM 8 kHz,
Audio input/output	Built-in microphone (can be disabled mechanically)
Built-in microphone specification	50 Hz - 16 kHz
Speaker	
Max sound pressure level	>125 dB/30W/1m
Frequency response	300 Hz - 8 kHz
Coverage pattern	70° horizontal by 100° vertical (at 2 kHz)
Amplifier	
Amplifier description	Built-in 30W Class D amplifier
Supported protocols	IPv4/v6, HTTP, SIP, RTP, TCP, UDP, DHCP

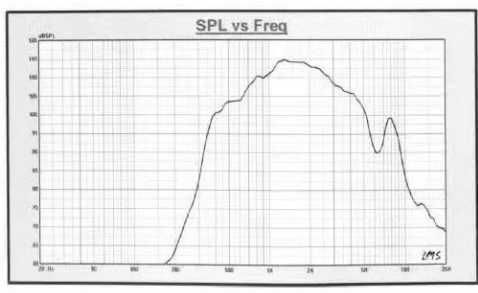
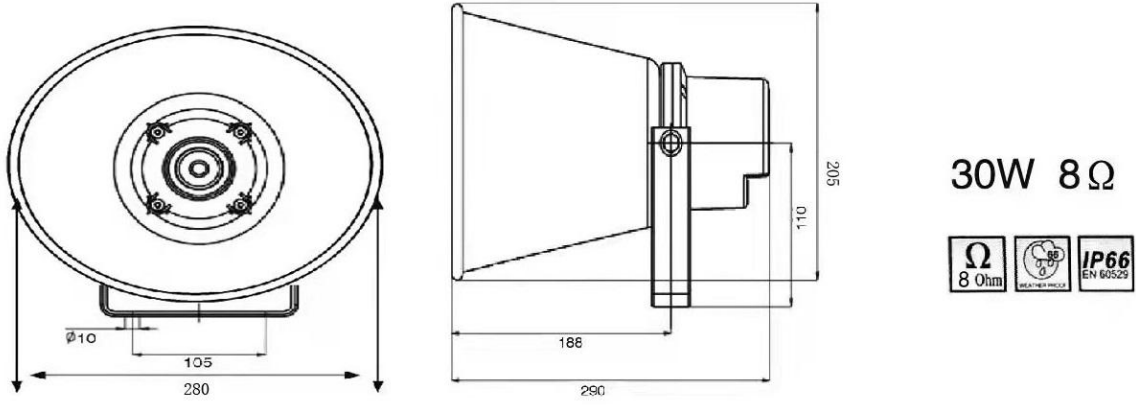
General	
Casing	Impact-resistant aluminum, IP66-and NEMA4X-rated. For repainting instructions and impact on warranty, contact your partner
Memory	256 MB RAM, 256 MB Flash
Power	AC110~240V
Connectors	RJ45 10BASE-T/100BASE-TX
Operating conditions	-30°C to 70 °C (-4 °F to 122 °F) Humidity 10~100% RH (condensing)
Approvals	
Dimension	280*205*290 mm

Dimension:



Key to symbols used	
	Weatherproof
	IP rating EN 60529
	100V line
	Low impedance
	Double insulated



infinite possibility

Web: www.koontech.com
 Email: marketing@koontech.com
 Tel: (HK Office) +852 9068 2799 / (Shenzhen Office) +0086 0755 2744 8753
 Shenzhen Office: T3 1001, Yifang Center, Baoan, Shezhen, China
 HK Office: Unit C5, 11/F, Ka To Factory Building, 2 Cheung Yue Street, Cheung Sha Wan, Kowloon, Hong Kong
 Factory: KNTECH Building, Phoenix Mountain, Limhai Zone, Shajiao Community, Humen, Dongguan, China